

The brain is primarily a visual-spatial processing device: altering visual-spatial cognitive processing via retinal stimulation can treat movement disorders.

Clark Elliott
College of Computing and Digital Media
DePaul University
1 DePaul Center
Chicago IL 60604
Elliott@depaul.edu
(312) 362-8627

Keywords: Concussion, mTBI, Movement, Neuro-developmental optometry, Retina, Cognitive Restructuring.

Citation: Clark Elliott (2017), *Functional Neurology, Rehabilitation, and Ergonomics*, Vol. 7, No. 3, pages 24-38, Nova Science Publishers. All rights reserved. Academic fair use only.

ABSTRACT

This paper presents portions of a ten-year self-reporting case study relative to movement, based on my book, "The Ghost In My Brain." As an artificial intelligence and cognitive science professor I took 1,200 pages of detailed notes over the course of eight years, of the effects of mTBI, with no expectation of recovery. Symptoms included many deficits in movement: significant and varied balance difficulties; loss of where the body ends yielding, e.g., difficulty passing through doorways; loss of spatial relationships; catatonia, including progressive inability to initiate motion under brain stress; ability to dance but not walk; visually guiding the hands toward objects; seizures; loss of concepts such as "center" making it hard, e.g., to put keys in locks; inability to turn right; the "dolly zoom effect" when walking toward a distant goal; and so on. A clear pattern arises: when the mind cannot conceive spatial relationships, the body will not move. During eight years that included MRI, CT scan, neurocognitive testing, etc., medical science was consistent in the opinion that I would never improve and should learn to live with my symptoms. After neuro-developmental optometric treatment via retinal stimulation and cognitive restructuring using visual puzzles, all cognitive and movement abnormalities were resolved within two years. The bulk of the improvement was in the first few months.

PROLOGUE

In this article I present an unusual ten-year self-reporting cognitive case study of a serious mild traumatic brain injury (mTBI), therapeutic treatment with retinal stimulation beginning at year nine, and ultimately full recovery. Treatment consisted of cognitive restructuring using visual puzzles, in conjunction with neurodevelopmental optometric rehabilitation techniques and therapeutic eyeglasses. Drawn from a larger body of work comprising 1,200 pages of original notes, the descriptions and commentary in this article focus on cognitive aspects of the human experience relative to movement. In addition to presenting the most salient features of the case, I will argue that human cognition—including the cognition that drives movement—is largely visual-spatial in nature, and that any full study of movement must include a detailed understanding of retinal-related processing in the brain.

Since publication of my book “The Ghost In My Brain: How a Concussion Stole My Life And How The New Science of Brain Plasticity Helped Me Get It Back,” (1) and media interviews reaching more than ten million viewers and listeners, I have heard from readers all over the world, with the most common theme being some passionate form of “You are the first person in [two/five/ten...] years who ever described my experience of living with brain injury.” This suggests that many thousands, if not millions, of those with similar brain trauma have symptoms overlapping my own, and may also benefit from retinal-stimulation therapies that treat the visual-spatial systems in the brain.

We can argue that this is an unusual case as follows: (a) my metacognitive observer was intact, even at times of extreme cognitive breakdown, so that I could observe, and later record, many striking episodes in great detail. (b) I had skills as a scientific observer because of my background as a professor of cognitive science and artificial intelligence, (c) I took 1,200 pages of scrupulously detailed notes from the first day of injury through full recovery, and (d) one of the common features of my cognitive breakdowns was a great slowing in the sequences of movement through physical and mental problem spaces; we can at least suspect that this yielded a rare opportunity to make valid observations of the steps that underlie normal cognition, but which steps ordinarily occur too rapidly to observe.

In this article I will give the details of some symptoms of the case relative to movement, followed by relevant testing, diagnosis, therapies, and recovery.

OVERVIEW

In 1999 I was directly rear-ended while waiting at a stoplight. The only impact was when my head bounced off the driver's seat headrest. I lost consciousness for less than two seconds. Afterward I ignored EMT advice to go to the hospital and instead drove to deliver my evening lecture at DePaul University in Chicago. Almost immediately strange cognitive problems began manifesting themselves. I was later diagnosed as having suffered a severe concussion. CT scan, and MRI were negative with just the slightest hint of possible damage in the occipital lobe. X-Ray showed slight damage to the C4/C5 vertebrae and surrounding

ligaments from whiplash. Neuropsychological testing indicated mTBI. Psychological and psychiatric evaluations were normal, but with indications of mTBI. Balance testing showed problems with inner ear processing. I lived with often dramatic debilitation from the head injury for eight years. I showed minor scaffolded improvement after one month, six months, one year, and two years, then no improvement at all after that.

I sought specialist help at rehabilitation centers, sports rehabilitation offices, neurologists specializing in head injury, balance therapy, psychiatrists specializing in head injury, acupuncture, deep massage therapy, myotherapy, cranial-sacral manipulation, standard chiropractic and atlas chiropractic help, etc., all without more than an occasional very minor and very temporary relief of symptoms. SSRIs had no effect. Very low doses of methylphenidate were slightly beneficial in getting through short periods of difficult cognitive challenges relating to my job (such as the grading of exams). I was repeatedly told by specialists that no one ever recovers from this kind of brain damage and that I should learn to live with my symptoms.

In early 2008 I began retinal-stimulation treatment with visual puzzles (lasting six months) and therapeutic eyeglasses. I showed dramatic improvement within one month, and full recovery after two years.

Some of the clinical records are lost. The case was not of much academic interest until my surprising full recovery eight years after the original incident. By then mandatory record-keeping periods had expired, and some clinical notes had been discarded.

CASE PRESENTATION: SYMPTOMS RELATIVE TO MOVEMENT

In this section I describe a broad sample of representative symptoms from long-term mTBI relative to movement.

BODY DEMARCATION SENSE

We suspected problems in my superior parietal lobe because under brain stress I had trouble distinguishing where my body ended, and where the external world took over. Without the capability to make this distinction, it was difficult at times for me to navigate through a world filled with obstructions and the appearance of visual pathways between them through which I was expected to pass. It is an interesting question to consider the relationships among the brain's visual cortex, its balance systems and this body-versus-surroundings demarcation sense. My experience suggests that there is a link. The following episodes with movement difficulties illustrate this problem.

First, I often had minor trouble getting through doorways, coinciding with visual disturbance and balance difficulties. After lectures, for example, I would typically get stuck trying to get out of the classroom. I had to have students push me through the classroom doorway out into the hallway, though once I was through the opening I could walk on my

own. From an experiential standpoint I could see the opening without difficulty and I could fully describe it in the usual way. But I was not able to make useful spatial sense of it, and I specifically had to “feel” for the doorway visually by observing my hands reaching out to touch the framing of the opening. It was as though I had to mentally re-construct the delineation of where my body ended, and the doorway began in the visual space before my eyes, before I could form the motion goals of walking my body through the opening.

Second, there was an illustrative episode that arose several years after the crash. It was necessary that a fifty-foot diseased tree on my property be cut down, and much as I loathed the idea of climbing up in the tree with my brain difficulties, circumstances dictated that I was the one that had to cut it down. This task—over several weeks—taxed my spatial planning systems in (a) determining where the heavy branches would fall after I cut them, in (b) requiring that I extract meaningful real-time information from the barrage of sensory input; and in (c) requiring that I keep my balance thirty feet in the air based primarily on the constantly shifting visual cues of the leaves blowing around in the wind and flickering in the sunlight.

I soon lost the sense of where the branching of my body ended and the differential branching of the tree limbs began—not an optimal circumstance when one is standing on those same branches, and cutting through them with a chainsaw. I had to manually walk myself repeatedly through the geometry of the environment, tracing body parts back to the center of me, and tree parts back to their terminus in the small leaves or the trunk.

Once down from the tree, after each such episode, I was not able to walk for quite some time, and indeed it took a while before I could even crawl back into the house. Part of the

difficulty in walking at those times was that when I lost the sense of distinction between my own body and the rest of the world, I was unable to clearly form the concept of *me vs. not me* as a subcomponent of walking (or crawling) from *here to there*, and despite my intellectual desire to do so, my body would simply not move.

NEGLECT

At times of brain fatigue I would lose spatial qualities in the right side of my world, in episodes that imitated a mild form of neglect. This affected large body movements in several ways. At such times I had difficulty turning right, and instead would naturally turn all the way around to the left to achieve the same outcome. Some specific examples: (a) There were times when I had to turn 90 degrees to the right to get into a car (which sometimes included the additional difficulties with passing myself through an opening as mentioned above). But I found I couldn't conceive of turning right, so I would instead have to turn 270 degrees around to the left, or in some cases, in a bobbing/dancing movement I would turn 630 degrees to the left in a spinning motion, then release and use the centrifugal force to throw myself through the opening. (b) When running around an oval track with one of my children beside me, I had to place *myself* on the left. If I was on the right, then spatially I had to conceive of myself, and the various running motions of my body, as being present on my difficult right side in the coordinated running movement with my child. I would become nauseated within minutes if I was on the right, as I struggled with the geometry. (c) At such times I also had trouble with the right-hand side of the visual-

spatial symbols of internal imagery. For example in conceiving of the x-axis in coordinate space, the left-hand side of the line image and the concept of the smaller numbers was clear, but the right-hand side grew increasingly fuzzy the farther to the right I went, and the associated concept of “larger” was thus also a struggle.

Experientially I would feel this “neglect” in the way one might feel congestion with a head cold—a thickness and occlusion of sensory information, and cognitive imagery, but only on the right side and not in my head but rather in the larger space around me.

With respect to movement I tended not to have trouble with smaller right-hand side movements, but rather mostly with the larger movements of guiding my body through the space around me.

DOLLY ZOOM

One of the more disconcerting difficulties in walking from one place to another was a visual disturbance related to the *Dolly Zoom* effect used in movies. (A famous use of this technique is in the opening scene from Hitchcock’s *Vertigo*, when Jimmy Stewart is hanging from a rain gutter: the foreground stays the same, but the surface of the concrete alley below drops away into the distance.) This same effect would happen to me at times of brain fatigue when I had to press myself to keep walking—especially in visually complex environments, such as blowing snow. The nightmarish result was that with every step I took forward, the distant goal toward which I was walking appeared two steps farther away. During the process of this deterioration of my cognitive depth perception I would

move slower and slower, guiding my feet manually, until ultimately I would stop moving altogether. This quite dramatic deterioration on several occasions left me stranded in freezing cold weather for more than forty-five minutes before I could initiate walking again.

Two principles suggest themselves: (a) when the mind cannot conceive clear spatial goals, the body cannot follow those goals to move through space, and (b) the act of walking through space requires visual-spatial processing that precedes the actual motion. In my case the cognitive demands of walking caused significant cognitive deterioration through fatigue and this was noticeable in the breakdown of the competitive uses of those spatial parts of my brain needed for scene interpretation.

DIFFICULTIES WITH CONCEPTS, THE *CENTER* OF THINGS

At times of brain stress I would lose the ability to form geometric conceptual information, and this affected movement as I coincidentally lost the ability to form the low-level shape-based visual-spatial goals required for intentional movement. For example, one of the concepts I would lose was that of *center*. This affected gross body movement through space, and also the finer movements of guiding my hands in relation to *center* with respect to reaching, putting, and grasping goals. An example of the former is that this contributed to my previously mentioned difficulty in getting through doorways—the passing of my body through the center of the opening.

Examples of difficulty with the guided movement of my hands are as follows. (a) I often had great difficulty in getting keys into door locks. Intellectually, I knew exactly what the task at

hand was. I had no difficulty with my vision, per se, and could fully describe the visual scene details of my hand, the key in it, and the features of the doorknob surrounding the keyhole. This produced numerous episodes from the frustrating (ten minutes trying to guide my key into the lock so I could open my front door), to the embarrassing (trying not to look like an intoxicated person, opening my office door at work when there were casual observers around), to the frightening (almost freezing to death one frigid Chicago evening when I could not guide my key into the lock of my car door, after I had already all but lost the ability to walk). (b) At times after an evening lecture, and the subsequent four-hour trip home (because of difficulties of traveling with brain injury), using the last of my energy I would finally finish preparing a meal. But I sometimes found I couldn't eat it because—although fully lucid, and fully able to see the plate of food in front of me—I couldn't guide my fork toward the opening of my mouth. I couldn't “see” the center-oriented spatial goal in my mind's eye, and my arm and hand would simply wander in space without it.

STAIRWAYS AND THE LINES OF SPACE

One movement problem that showed up within hours of the crash and was persistent for eight years, had to do with walking through environments that had parallel lines in them. I will give three examples.

First, I often found that I could walk up stairs without much difficulty, but at the same time I could not easily walk down those same sets of stairs. There is a gently curving stairway from floor two to floor one in one of the buildings where I would teach. For a full quarter I

would walk up the stairs without much difficulty, but often found myself frozen, unable to move, when on the top landing, trying to walk down. In the worst case I would be stuck there for up to ten minutes unable to move at all. The remedy was to ask someone to push me down the stairs while I held on to the handrail. Once I got started, then using the handrail I could get down on my own without incident. Experientially, once again I could see the stairs visually in the usual way, in full detail. But I could not comprehend the spatial nature of the sets of parallel lines, and I could not understand my own body in relationship to the lines.

Second, in a library near my house there are aluminum and cloth parallel bands comprising the floor of a large entry way, so that snow can be knocked off boots and drained away through the gaps in the slats. The bright aluminum forms long parallel lines over which patrons have to walk to enter the library. I was never able to pass through this gantlet without someone pushing me. As soon as I saw the lines my body would freeze in place. Closing my eyes did not help, because I still internally visualized the bands in attempting to walk across them blind.

Third, I was unable to easily pass through Jetway tunnels when getting onto or off of airplanes, and had to be pushed through them. Jetways have concentric banded lines throughout their construction. Similar to my problem with stairs, I had more trouble walking down a Jetway than walking up one.

BALANCE

My balance difficulties were many and varied, and as can be imagined the effects on my ability to move through space were profound. The full topic is beyond the scope of this article save for two interesting aspects of balance difficulties highly relevant to the theme of this article.

I had unspecified inner ear damage from the crash, diagnosed through eye-movement tracking and in various other ways. Specifically, I had to use my visual system (along with my proprioceptive sense) to make up for inner ear deficits. But this placed often-unworkable demands on my also-compromised visual-spatial processing since I also had to use those same damaged visual-spatial processes to construct the basic symbols of thought. This meant that there was competition for these already scarce resources, and with overload I was often soon spiraling down toward cognitive breakdown, and physical catatonia. The result was that I often found that I could either think, or walk (or perform other physical tasks that made demands on my balance system) but I couldn't do both at the same time. This is further evidence that visual-spatial processing drives movement.

CERTAINTY, NOT KNOWLEDGE

The making of decisions was often difficult and exhausting for me, and occasionally impossible, although prior to the injury I had had no difficulty with the decision process whatsoever. Such difficulties affect movement, because when a person is having trouble making decisions, they will have trouble initiating the movements of actions that

subsequently follow. In the meantime, while waiting for a decision to arrive their body may simply freeze up. This happened to me regularly.

There was a clear distinction for me in the intellectual *knowing* of which choice might be preferred (which capability was still cognitively intact), and the *certainty* that allowed the pulling of a trigger on initiating subsequent action (which capability was cognitively absent). Without this mysterious certainty, the body won't act and won't initiate movement.

At the worst of times you might tell me to arbitrarily pick either my left hand, or my right hand, turn it palm up, and you'll give me a thousand dollars—but I would still not be able to pick one, because I simply could not *decide*. Without the certainty of decision, my hands would not move.

Definition of this abstract concept of certainty is elusive, but it has a definite visual-spatial element to it. Certainty represents the weighty grounding of an ephemeral thought-symbol goal within the spatial representation of the physical world that drives movement and action.

The making of a decision also requires that the possible choices also be enumerated some way in the internal spatial world. This may be represented as some left-to-right spectrum, as a high-low delineation, or something much more abstract, but under the hood it typically will involve some spatial distinction. Once the choices have been captured in a symbolic, visceral, spatial way one of the choices is marked within the 3D spatial representation as the goal, and the body responds by speaking, or reaching, or moving to execute the action. But in my case, at times of brain fatigue, I would not be able to form the clear symbols

representing a decision, and consequently could not choose one within the 3D space as the goal of a subsequent action.

In one instance, when arranging for a snack I made the mistake of taking out a piece of uncut salami and an apple, and then had to decide which one to prepare first. But I simply couldn't decide, because I couldn't form the clear spatial symbols of what a decision was. Without the certainty of a decision, my hands would not move. I could not make the leap from the thought symbols of, e.g., knowing that it didn't make the slightest difference which one I prepared first, to the certainty of having decided to cut up the apple, followed by the salami. In this carefully documented episode I went hungry for two days, and made ten fruitless trips back to the refrigerator before finally giving up and calling a friend for help.

COMMANDS AND RULE-FOLLOWING MODE

Two of the remedies I used, to deal with the difficulties of my inability to initiate action are worth examining. First, although the verbal and mental commands I gave myself to act when I was stuck had no effect whatsoever, the spoken commands of others did. In the episode just discussed—of my inability to form the decision of which food to prepare first—the final solution was to call my friend Jake and tell him to command me what to do. He instructed me to eat the salami first, and in that moment my two-day problem was thus resolved. The audio signal from another was sufficient for me to set the clear spatial goal that allowed for action to take place: my feet could walk, my hands could reach. I used this technique often, sometimes literally telling others exactly what to command me to do: get

up out of the chair I had been stuck in, move my left foot forward so that I could get walking down the hall, and so on.

Second, on occasions when I knew that decisions were going to have to be made, I would put myself in what we might call “rule-following mode.” In this state I would follow rules whenever possible, to avoid making choices. This reduced some of my challenges, but it was not a perfect solution in a messy world where rules did not always apply. Furthermore, it highlighted the difficulty I had in switching between rule-following mode, and choice mode, which are cognitively distinct, and states between which normal brains effortlessly travel throughout the day.

On one occasion I was to meet with my friend Jake for dinner. This activity has many decisions that are sub-components: when to meet, where to meet, who is driving, where to eat, where to park, where to sit, what to eat, and so on. So I put myself in rule-following mode, which idiosyncrasy of mine Jake understood well. After parking, we were walking down the street on the way to the restaurant. I glanced up to my left, and saw a sign on an electronics store that said, “Come in!” I immediately froze in place. Try as I might, the best I could manage was to *not* go into the store. But I was incapable of continuing on our way to the restaurant. The problem of course was that I was following rules (*park where Jake decides, order the first edible choice I encounter on the menu, and so on*), and because of the brain damage I was not well able to easily shift between that mode, and one embracing choice which would allow me to choose to ignore the command given by the sign.

In another instance I was running the Chicago Marathon. There is a great deal of sensory input during such races with the bright morning sun, the crowds comprised of millions of

vocal supporters, the colorful banners, the altered body state from the physical demands of running, and the sea of motion among the runners. To help avoid being overwhelmed I put myself into rule-following mode: *Follow all race-official instructions. Follow the signs for runners. Follow after the runners before me in the race. Turn when they turn*, and so on. I could manage the twenty-six mile race without too much trouble except for one aspect that was so debilitating at times that I became sick to my stomach, and feared I would have to drop out: The race course was entirely blocked off to traffic. The runners passed through traffic lights without concern. But when I encountered red lights, the rule ingrained from childhood was: *STOP*. This required that I choose to follow one rule (*do whatever the other runners are doing*), and ignore another (*stop when you see a red light*). Ordinarily brains can switch between the following of rules to direct movement, and the making of choices to direct movement without much difficulty. For me it was a great challenge.

To see how the commands of others direct our movements at a pre-conscious level consider the common childhood game *Simon Says*. In the game a caller gives instructions preceded by the phrase “Simon says...,” which commands are to be followed directly: “Simon says step forward with your left foot!” If the caller leaves out the special phrase and says instead only, “Step forward with your left foot!” the command is to be ignored; those players that follow this second form of the command are out of the game. But despite the fact that every player is intent on ignoring such commands as the latter, sooner or later everyone’s pre-conscious imperative to move in response to commands gets the better of them. Rule-following mode, and our ability to gracefully move into and out of it, is a normal part of human cognition—unless you have brain damage.

CATATONIA

I suffered various degrees of catatonia—the inability to initiate movement (though in my case with full mental faculties)—through the eight year period of my injury prior to successful treatment. Several instances of this are covered elsewhere in conjunction with e.g., losing my body demarcation sense, cognitive exhaustion from pushing myself to walk through visually complex environments while having balance difficulties, and when attempting to make decisions.

Problems with catatonia would very typically be a problem for me at times when sensory input required that I create, in real time, the visual-spatial symbols of thought to interpret it—in particular the translation of audio input, such as speech, into thought-symbols and images. The problem was compounded when I had to additionally manipulate the real-time thought symbols into new forms, such as when making decisions, when trying to reason about time, calendars, and plans, or when making inferences from scholarly presentations.

A typical example was when our tenured faculty at the university would meet to discuss the tenure recommendation for a candidate. Because these decisions were so very important in the candidate's life—and because it was clearly part of my job as a senior faculty member—I felt I had to attend these meetings regardless of my physical and cognitive state. But these meetings required careful attention to the audio stream presenting speech, required the interpretation of data and arguments, and required the making of many decisions along the way to the final vote. At the end of such meetings I was invariably unable to move. Various remedial strategies involved reserving the meeting

room after the meetings so that I could sit for an hour doing absolutely nothing while recovering my ambulatory abilities, and having colleagues pull me up out of my chair and push me down the hall on my way to my office.

SEIZURES

When executing the visual pursuits necessary for following the geometric rotations of two-sided photocopying, I would get mild brain seizures. If I worked through a short job (less than four minutes) that required me to make 3D spatial mental plans for manually translating (rotating with my hands) double-sided paper input into single-sided photocopier output, or vice versa, I would get seizures that would last about fifteen minutes. If necessity dictated that I press myself to complete a larger job of twenty minutes or more, the seizures would last for up to three days.

The seizures would begin gradually. The period of the side-to-side tremble remained constant at 126 cycles (shake left, and back to the right) per minute, but the travel would start out very slight—about a centimeter—and then increase under duress to about five centimeters at my nose, and fifteen centimeters in my hands. My arms moved in tandem so that when my left came in, my right went out and vice versa. My eyes stayed focused on objects, and I had no trouble seeing. If I tried to produce the movements without having the seizures I could not manage the coordination and would get tired within a minute. By contrast, when I had the seizures they might last for days, and I didn't feel any muscle

fatigue at all. If I forced myself, I could get the seizures to quiesce temporarily, but as soon as I relaxed, or focused on something else, they would start up again.

I could also produce the seizures by drawing concentric circles on a sheet of paper, once again within about four minutes. See Figure 1.

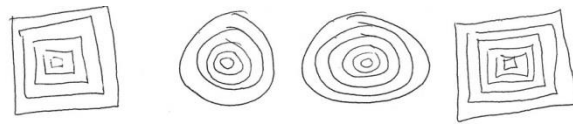

Figure 1 Concentric circles that initiated seizures.

NORTH, SOUTH, EAST, WEST

When studying at the Eastman School of Music I found that one class of musicians—those with absolute pitch—heard musical notes in relation to a fixed grid that was constant according to frequencies in the physical world, and another class of musicians—those with relative pitch—heard musical notes in relationship to one another, with no absolute connection to the physical world. Those in the first category would be driven to distraction if a record player platter was spinning too fast, and thus producing, e.g., Beethoven’s Fifth Symphony in C-sharp minor; those in the second category would immediately adjust and not be much bothered about it.

In this same way there is a spectrum in just how bound people are to the actual North, South, East, West (NSEW) orientation of themselves within their local environment at any given moment in time. I was at the end of the bell curve in being absolutely bound to my actual orientation on the face of the earth at all times. Not only was it important for me to each moment be situated within the real compass grid, but all of my memories were encoded this way, as were even many of the basic symbols of my thinking. I also performed exceptionally well on mental rotation tasks like those studied by Shehard and Metzler in the 1970s, and there is thought to be a link between compass orientation and mental rotation capability.

After the crash I immediately lost all sense of direction—my place on the natural grid on the face of the earth, and also, as discussed elsewhere, showed immediate deficits in making mental rotations. This gave me significant difficulties in moving through map space on campuses and around the city. It was also very significant in the loss of my ability to encode visual memories in episodic memory, and in memories of social interactions: formerly I had an absolute memory of the NSEW orientation of each actor in a scene, encoded along with what they were saying and doing, and along with an absolute NSEW orientation of the physical line that could be drawn between any two actors within a scene; after the crash my memories were much more chaotic, and with no spatial grounding. Something like: (a) forty-one years ago I bought an Austin Healy sports car from a stranger in Hayward California. When he handed me the title to the car the man was facing south-south-east. The sun was casting shadows behind him almost perfectly to the north, contrasted with, (b) yesterday I spoke to two people about an insurance policy but I am

having trouble placing them in space and I thus can't remember exactly what they were saying to me.

This difficulty with NSEW orientation also affected my dreams, both in the grounding of scenes within my dreams and also in understanding the meaning of motion within my dreams, leading often to a feeling a frustration. I further had difficulty naturally linking my dreams to the real-world initiating problems and events that had prompted them, leaving me with a feeling that my sleep was no longer productive.

For a person who naturally moves through the world and encodes scenes within it using an absolute NSEW grid, losing it overnight is, on a spatial level, a catastrophic failure.

SWITCHING BETWEEN PERSPECTIVES, AND MIND-READING

One of the facilities that humans have, and rarely consider, is what sometimes has been referred to as "mind reading" in cognitive science. This faculty allows us to coordinate our movements, and social life with others by *changing perspective* to feel, or imagine, the world from the point of view of another.

To illustrate this natural facility, consider that I may feel somewhat distressed on your behalf because your wife's mother's Labrador Retriever has been throwing up on the living room floor in the mornings. The logical chain through our emotional recursion in this case (each step of which requires one further step in "mind reading") is: I am presuming that you feel badly that your wife might be worried because she is presuming that her mother is feeling badly for her dog because she in turn is presuming that the dog is distressed. In fact

you might not like your wife and be gloating that she is distressed. Ditto that your wife might not like that her mother dotes on her dog, and is gloating about it, or that the mother doesn't like the dog or is angry that he is so much trouble. In fact the dog might be eating dead squirrels in the park every morning and happy as a clam at high tide to come home and throw them back up in the house later, and thus we see that the entire recursive structure is purely a natural—effortless—mental exercise in “mind reading.”

With respect to movement, one of the ways we coordinate our physical actions with others is by gracefully, and throughout the day, switching our context to imagine how life is, from the locus of another's point of view in the space between us, and around the both of us. At times of brain stress I would lose this natural switching ability, and have to manually walk myself through the switching of contexts. Having to manage this as an intellectual task, I was surprised to find how very often this occurs—without conscious thought—throughout a normal day, and how exhausting it was to have to manually force the shift in point of view—which is actually quite complex in nature—myself.

Because of my own challenges I also became sensitive to this ability as a spectrum in others: I observed that some were graceful and fully functioning; others were to one degree or another less graceful in ways that also happened to me at times of brain fatigue. I saw this ability show up in many ways. Some people had difficulty when they walked just slightly too close to another and bumped into them periodically, or had trouble coordinating the tandem motion of feet when walking beside a person. Others had difficulty that showed up as stopping and starting when they crossed a street through traffic, and would cause other pedestrians to bump into them. Some people moved in too closely to others, or were too far apart, when they talked to them. Some drove too close to the car in

front of them on the highway. Because of my sensitivity to these differences, I trusted my intuition that all of these oddities were at least partially linked to an inability to fully appreciate the point of view of others within the spatial environment, or at least the inability to gracefully switch contexts fast enough to achieve the desired result.

CLINICAL DIAGNOSIS AND TREATMENT

NECK INJURY

The impact from the crash was enough to damage ligaments and one of the vertebra in my neck.

Michael Szatalowicz, D.C., writes:

Clark's cervical spine extension radiograph revealed 2.5 mm of posterior translation of C4 relative to C5 and increased disc space widening at the C4 disc space. This is evidence of ligament instability/injury of the anterior longitudinal ligament and the annular fibers of the C4 disc. There was also 2mm of posterior translation of C5 relative to C6 with disc space widening at the C5 disc, indicating ligament instability/injury of the anterior longitudinal ligament.

The flexion, extension and neutral cervical spine projections revealed what appears to be a "rim lesion" defect/injury which is noted at the anterior superior aspect of the C4 and C5 vertebral bodies. Note that the disc is attached to the vertebral bodies and when abrupt

extension of the cervical spine occurs in whiplash, the disc can actually pull a small portion of the bone or superior end plate away from the main body of the vertebrae resulting in the rim lesion. As in Clark's case, this appears as a radiolucency on the radiograph.

DEBORAH ZELINSKY, O.D., AND NEURO-DEVELOPMENTAL OPTOMETRY

In February of 2008 I met with Deborah Zelinsky, O.D. who emphasized neurodevelopmental optometric techniques in her practice, for testing and to begin treatment (2).

NEURODEVELOPMENTAL OPTOMETRIC TESTS FROM 2008-02-05 AND RESULTS

King-Devick—normal for saccadic eye movements.

LANG STEREOTEST II—normal.

Yoked Prism Walk—normal when the light was bent from the top and bottom orientations, and the right lateral orientation, but I had great difficulty in walking when the light was bent from the left lateral orientation.

Padula Visual Midline Shift Test—normal, though my difficulties with kaleidoscopic and chaotic vision mimicked those of people who have problems with this test.

ATNR (Asymmetrical Tonic Neck Reflex)—an ATNR was present when I turned my head to the left.

Selwin Super Fixation Disparity Test—my overall habitual eye position was slightly outward at the very limit of the normal range.

Van Graefe Phoria Test—my habitual eye aiming was perturbed. My eyes pointed inward at a distance, and far outward when focused on close-up objects. This caused an exhausting lag in cognition when my eyes had to continually re-aim to avoid double vision.

Visual Localization Test—I was completely unable to find the tip of the pointer with my eyes closed, in any quadrant. Further testing showed that my vision was fine and that faulty “where I am” signals were the culprit.

H-Pursuit Test—normal.

Near Point of Conversion Test—normal.

Confrontational Visual Field Exam—normal.

Z-bell Test (eyes closed throughout)—No glasses on / existing glasses on | bright light: unable to find any of the bells in any quadrant.

PHORIAS / VERGENCES

Exam date		Distance		Near
2008-02-05	lat	3 eso	lat	10 exo
	vert	Ortho	vert	ortho
	BO	x/18/16	BO	x/26/12
	BI	6/5	BI	x/28/22
			accom	+1.25/+0.25
2008-02-26	lat	Ortho	lat	6 exo
	vert	Ortho	vert	ortho
	BO	x/16/12	BO	x/20/12
	BI	8/2	BI	x/12/10
			lag	14a +0.75
2009-10-23	lat	2 exo	lat	7 exo
	vert	½ BD OS or ½ BU OD	vert	½ BU OD or ½ BD OS
	BO	8/14/10	BO	10/16/8
	BI	6/4	BI	12/18/14
			accom	Range 10-24" with +2.00 add
2011-06-22	lat	Ortho	lat	5 exo
	vert	Ortho	vert	ortho
	BO	x/18/6	BO	x/24/12
	BI	6/2	BI	x/12/8
			accom	+0.25/+2.75
2012-06-09	lat	Ortho	lat	ortho (AC/A +6/1)
	vert	Ortho	vert	ortho
	BI	6/2	BO	x/22/10
			BI	x/12/4
			accom	+1.75/+2.75
2013-06-05	lat	5 eso	lat	2 exo
	vert	Ortho	vert	ortho
	BO	x/32/26	BO	x/20/16
	BI	6/2	BI	x/18/14
			accom	-0.50/+2.00

TREATMENT AND COMMENTARY

To address the neurological issues revealed by the neurodevelopmental optometric testing and Dr. Zelinsky's clinical evaluation, I was given six different pairs of therapeutic prescription eyeglasses over the course of four years. By the end of the period with the first three prescriptions, I was all but fully recovered, with only minor tweaks for mental haziness to follow.

Deborah Zelinsky, O.D. writes:

Clark's first prescription 2008-02-05:

Manifest:

OD -1.25 sphere 20/20

OS -1.50 sphere 20/20

Prescribed instead a pair of therapeutic lenses:

OD +0.12 sphere 0.5 Base IN

OS +0.12 sphere 0.5 Base OUT

RATIONALE: This first therapeutic pair had two components—one for the body directly (through the directive lateral yoked prism), and the other for peripheral awareness.

Although Clark's central eyesight was not clear until -1.25 units of power were used, that prescription would only compensate for his blurry central eyesight (nearsightedness). Clark had a fragile connection between his central and peripheral eyesight systems. The more the central system was sharpened, the more distorted his peripheral system became. Clark was having trouble perceiving global context within visual scenes and was therefore prescribed lenses designed for peripheral stability. The "delayed gratification" of seeing clear central targets was discussed with Clark and he was OK with the slight blur at the beginning of his rehabilitation process. The yoked prisms were designed to make Clark's body more comfortable; the amount and balance were based on Z-Bell testing of Clark's non-image-forming retinal pathways. That testing determined which lenses provided the most solidly synchronized eye and ear systems for perceiving the spatial 3D world around him.

My commentary: I had no expectations that glasses and working with puzzles would help me. I had been to many specialists without any result for almost a decade. Yet with this prescription I experienced a profound change in my well-being, and by my estimate was about seventy percent recovered within the first month of wearing the glasses. I felt as though I was re-discovering my body and its relationship to the world the way a six-month old baby would learn about his. During this period I could not always manage the traditional body synchronization of walking, and would sometimes have to dance down the hallways at the university on my way to lectures and back. I went through profound changes in re-learning the deep meaning of concepts like *center* (discussed above), and *less than / greater than* that allowed me to again apprehend the meaning of higher level concepts like sequence, ordering, and planning. There was a profound change in my ability

to understand spatial soundscapes, and to make the meaningful placement of objects in the 3D world of my hearing such that I could form clear internal visual-spatial representations of them, and their relationships to other objects. I was once again able to form the internal images that allowed me to understand speech in the normal way. Above all I felt a return of my ability to represent the rich internal and external world of normal cognition, and that because of this I now had the representational power to support being a real person again; my long-alienated *self* could return at last from what felt like its eight-year exile from the human race.

I often felt frustrated with these glasses and complained to myself “I can’t see!” although from a conscious perspective my vision seemed fine. In relearning physical tasks that involved body movement, I was generally contorted and inefficient, but had the strong sense that I was making good progress toward again becoming comfortable with movement. I had a large increase in the number of calories I was consuming, as though my brain were starved for food. I noticed that I regressed when taking the glasses off for sleeping, so within days I took to wearing them twenty-four hours a day. (Even through closed eyelids the glasses modified input to my non-image-forming retinal pathways which still operated at night with the very low levels of light that passed through the filtering of my eyelids.) This had the added benefit of improving my sleep, and also gave me the feeling that my dreams (which are highly visual in nature) were less chaotic, and more productive.

I experienced these glasses as opening up the left side of my visual “working memory” space such that I could place symbols in that part of my spatial field and once again manipulate them in the usual way for solving problems. Thinking associated with this space felt creative rather than logical.

Dr. Zelinsky continues [etc. hereafter]:

Clark's second prescription, 2008-02-26:

OD -0.50 sphere 0.5 Base IN

OS -0.75 sphere 0.5 Base OUT

Summit ECP +1.25 add

RATIONALE: At a follow-up visit less than a month later, testing showed that Clark's central/peripheral balance was more stable and therefore he was able to withstand a small increase in the amount of nearsightedness prescription, and also a reading component. Although he could be made to see targets even more sharply, he would not have been able to tolerate the additional clarity which would again distort his periphery. The directive, lateral yoked prism remained. The prescription was slightly different in each eye now, similar to his original measurements.

My commentary: I was comfortable with these glasses and not as frustrated in trying to see. I experienced them as opening up the right side of my spatial field and that they had the cognitive/emotional feel of letting me operate in a logical and down-to-earth way. In the five months I wore them exclusively, and the year following when I traded off with my next pair, I made steady further progress toward being symptom-free. Cognitive tasks became easier and I was much less easily overwhelmed by sensory input. I was walking and moving normally. I did not experience the extreme cognitive and movement slowing of the previous eight years.

Clark's third prescription 2008-05-01:

OS -1.00-0.25 x 105

OD -0.75-0.50 x 075

Summit ECP +1.75 add

RATIONALE: Now Clark's central/peripheral balance was much more stable, and although he would have to work at adjusting, he did not need to continue wearing the yoked prisms for posture stability. In addition, he was able to now handle a slight amount of astigmatism correction to be able to see targets more clearly. This would require Clark's brain to adjust to the change between the two eyes. Clark found this prescription a challenge, and I instructed him to alternate between his second prescription and this one, until he could wean himself off of the prisms, and adjust to the astigmatism correction.

My commentary: I found these glasses difficult. I immediately missed the comfort the prisms afforded. I felt that the glasses were unbalanced, and that when changing my gaze from near to far, or vice versa, I experienced a slight lag in ability to comprehend the visual scene from one eye to the other. I traded off with my second pair for a year, then during a summer break from teaching wore them full time for a month, after which I was comfortable enough to use them exclusively. It was as though I had to "grow up" and give up the crutch of the prisms in the second pair, learning to be comfortable on my own. At the end of this period I was all but fully recovered in all practical ways.

Clark's fourth prescription, 2009-10-23 (Dr. K):

OD -1.00-0.25 x 130

OS -1.00-0.25 x 065

Hoyalux ID +2.00 add

RATIONALE: He had spent the past year and a half alternating between the third pair of lenses which had the slight astigmatism and no prism, and the second pair which had no astigmatism correction and a slight directive prism. He was prescribed lenses that were equal in each eye, with a small amount of balanced astigmatism and a slight change in axis. The equal prescription should be easier to handle.

My commentary: I was immediately calm and comfortable with this pair. Cognitively / emotionally they were very down to earth and sort of pedestrian in nature. I continued to make minor progress in small ways with cognition. At the end of a year and half I returned to Dr. Zelinsky and complained that while now leading a normal life I was a little fuzzy in my thinking and that it was as though I were looking at the world through dirty windows on a hazy August afternoon.

Clark's fifth prescription, 2011-06-22:

OD -0.50-0.25 x 130

OS -1.25-0.25 x 050

ID lifestyle +1.75 add

RATIONALE: Another year and a half later, the right eye didn't require as much prescription for clear eyesight and the left needed a small tweak so that the axes were balanced to 180. Again, Clark was accurate on the Z-Bell testing.

My commentary: With this prescription cognitive vibrancy returned, and the haziness was immediately reduced. I was effective and creative at work and in my personal life. After a year I returned to Dr. Zelinsky and—almost embarrassed to mention it—told her that for my work as a professor I felt there was another small tweak we could make: my upper right spatial quadrant was not as sharp as I thought it might be for forming mental imagery. When working on difficult problems as part of my research this area of my “mental working space” was not as clear as the rest.

Clark's sixth prescription, 2012-06-09

OD -1.00-0.25 x 110 0.5 Base DOWN

OS -1.50-0.25 x 065 0.5 Base DOWN

+2.50 add

RATIONALE: Clark was able to adapt to an axis change on his right eye, and his left axis returned to that of the fourth prescription. Directive prism was again added, but this time inducing an anterior/posterior shift.

My commentary: With these glasses I immediately felt calm, smart, intuitive, and creative and that my upper right spatial quadrant was now precisely in focus, allowing me to optimally work on the hard symbolic problems that were part of my work at the university.

I continue to wear these glasses for at least a few hours a day, and under the most emphatic insistence of Drs. Zelinsky and Markus (below) have not tested what would happen if I stopped wearing them.

DONALEE MARKUS, PH.D. AND COGNITIVE RESTRUCTURING WITH VISUAL PUZZLES

Donalee Markus, Ph.D. writes:

Diagnosis:

I first met with Clark in January of 2008 at my Designs for Strong Minds (3) clinic. Clark was greatly affected by his injury, and it is hard to imagine how he continued to work as a professor and take care of his young children. When meeting him for the first time, I gave him a complex figure drawing to copy (see Figure 2), to determine how he habitually organized visual material. Within minutes his body was contorted and I feared he would fall out of his chair onto the floor. My assistant was preparing to call 911 for an ambulance. Clark assured us this was normal for him, and he had been this way for years. When our initial assessment was over—which placed mild cognitive and visual demands on Clark—he had great difficulty getting up the stairway leading up from my basement office. Because Clark had clear visual-spatial processing deficits, I immediately referred him to my colleague Deborah Zelinsky, O.D., and we worked together on his case.

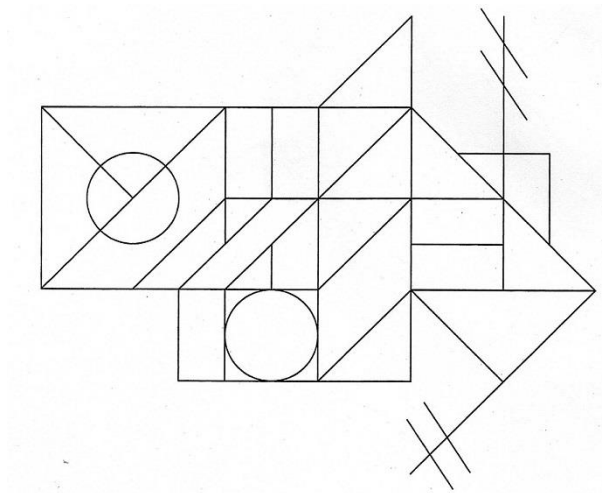

Figure 2 Complex figure that caused a physical meltdown at the first appointment.

Clark's metacognitive observer was intact, as was his ability to hold internal directed conversations with respect to achieving goals. His emotion systems were intact and functioning normally. He was not able to organize visual scenes in the normal way. He had low-level deficits in understanding simple geometric concepts, relationships, progressions, analogies, part-whole relationships, overlapping shapes, rotations, and structure. He had trouble forming plans. He had trouble understanding sequences.

One of the principles of cognitive restructuring rehabilitation after brain injury is that dispositional weaknesses often have to be addressed because compensation techniques for these problems are often the first to deteriorate. Clark had a dispositional tendency toward attention difficulties that I felt needed to be addressed as part of cognitive restructuring.

Treatment:

I worked with Clark for twenty-six weeks, in thirteen bi-weekly sessions of about two hours each. He had homework on which he spent at least an hour a day. At each session, after assessment, I gave him personalized stacks of paper-and-pencil puzzle exercises, chosen from the ten thousand I have at my disposal, which he completed at home. I reviewed his work at each session, and based on his performance selected the pace and content of his subsequent work with me. Clark was an excellent student who worked tirelessly at the exercises I gave him. His therapeutic eyeglasses helped with the speed of his progress.

Because much of the brain is devoted to visual imagery, and this imagery is the foundation of mathematics and abstract thinking, we began Clark's remedial recovery as a professor by re-learning the visual properties of basic geometric shapes. I gave him simple connect-the-dots exercises to tease out single triangles and squares present on a page with only a few distractor dots. (See Figure 3).

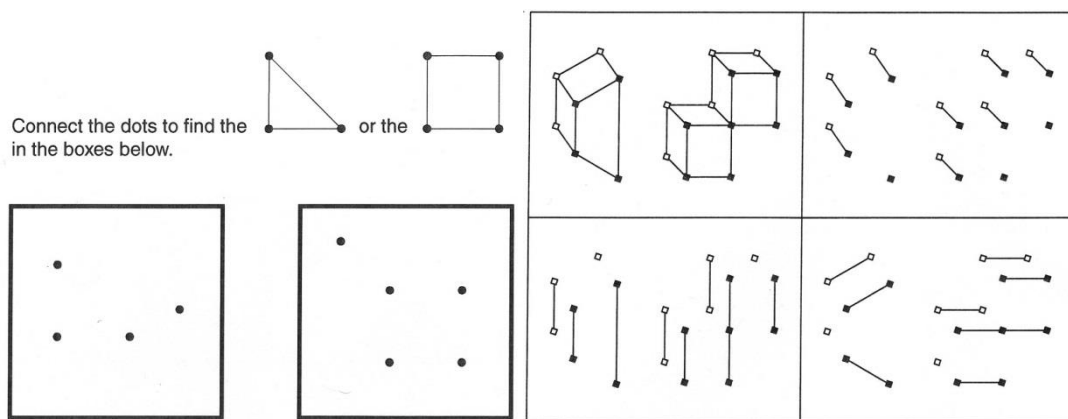
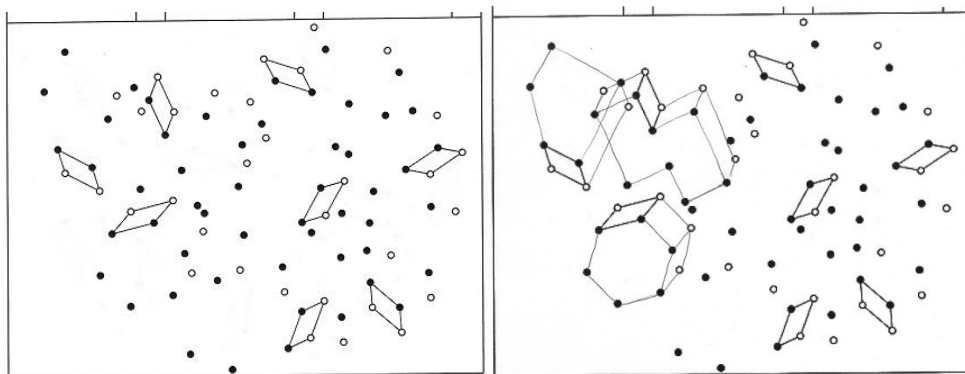

Figure 3 On the left, the simplest puzzles where Clark started. On the right, simple 3D dots puzzles with parallel line-segment cues.

When he had mastered the simplest shapes such as triangles and squares, we gradually added complexity: overlapping shapes, multiple instances of shapes on a page, 2D shapes, 3D shapes, symmetrical and asymmetrical shapes mixed together, and so on. Because Clark was a high-functioning individual we also had him rehearse complex images and rotations that overlapped.

Clark found that the 3D dots figure puzzles were particularly helpful for him in restoring the spatial reasoning he used in his work as a professor of artificial intelligence.

Toward the end of our work together I gave complex connect-the-dots puzzles to Clark with the idea that he would see the shapes and immediately trace them in pencil. Instead Clark felt he needed more of a challenge and would each day stare at the page for an hour or more until he could tease out up to fifteen shapes from more than a hundred dots simultaneously, all in his head. (See Figure 4 and Figure 5).



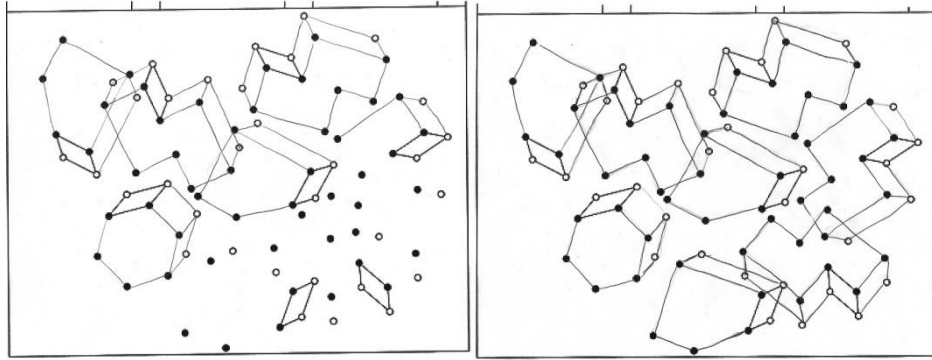
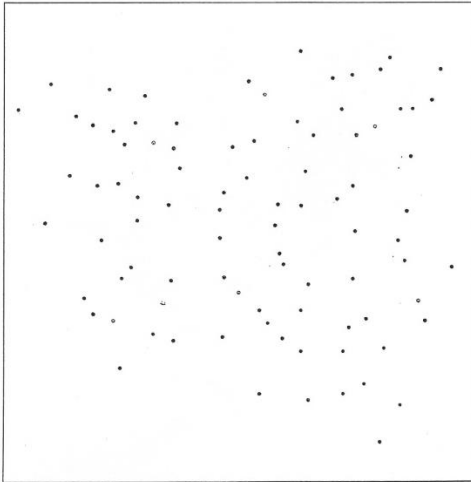
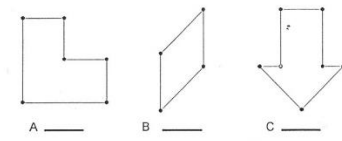

Figure 4 3D puzzles with many dots that Clark would work through as purely mental exercises for two weeks, then draw out prior to the office session.

However, as was apparent from the first office visit, Clark had difficulty synchronizing his movements, and the movement of his arms and hands in concert with visual/spatial goals. For this reason it was imperative that Clark not only complete the exercises in his head, but that he also translate his solutions into the motor movements that guided his hands by drawing the solutions on paper. So, at my insistence, after his purely mental exercise, he would trace all the figures on the page in pencil before he came to me for the next session.



000-10-9

© 1997 Donaltee Markus Ph.D. & Associates

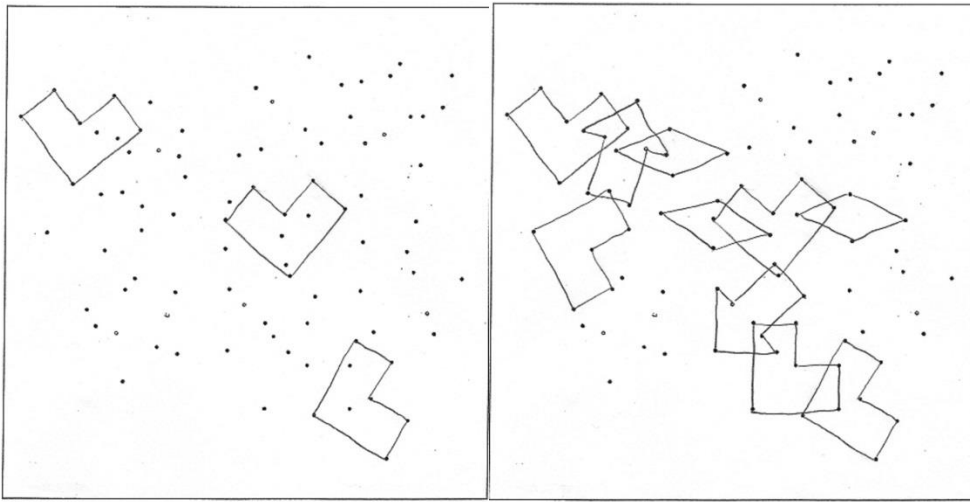

000-10-9

© 1997 Donaltee Markus Ph.D. & Associates

000-10-9

© 1997 Donaltee Markus Ph.D. & Associates

Figure 5 2D puzzles with many dots that Clark would work through as purely mental exercises for two weeks, then draw out prior to the office session.

I gave Clark exercises to re-learn and then rehearse analogies, such that he had to tease out the rule, and then apply it to a new problem: A is to A' as B is to B' , and so on. (See Figure 6).

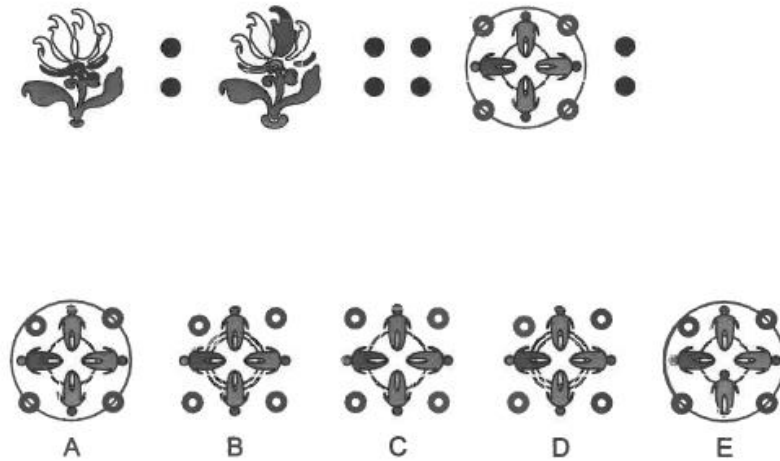

2203-1analogy

© 2008 Douglas Marlow, Ph.D. & Associates. All rights reserved worldwide.
For permission to replicate or use these exercises, please contact Douglas Marlow, Ph.D. & Associates, 484 Hillside Drive, Highland Park, IL 60038

Figure 6 Analogy puzzles.

To address stability in his metacognitive-directed internal conversation, to help him to maintain concentration and focus, and to work on weaknesses with attention, I gave him paper and pencil inductive and deductive reasoning problems starting simply, but ultimately manipulating up to seven variables.

In *analytical perception* problems I had Clark focus on the metacognitive voice describing and executing the *process* of working toward a solution which was then generalized to other situations.

With *figure analogies* I had Clark organize visual input when comparing unfamiliar situations to familiar ones and generating inferences. To do so he had to tease out the *rule*

that applied by describing, comparing and contrasting two elements, then generalizing the rule to new examples. (See Figure 7).

The image at the top of the page is the original.
The four images at the bottom have been altered.

Compare the altered images to the original and
to each other.

Determine which two variables **best** describe the
changes that are common to all of the altered
images when each is compared to the original.

On the right side of the page, find and circle
the two words that best describe the changes
all four altered images have in common.

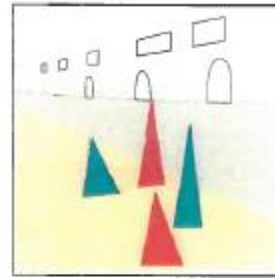

- Size
- Shape
- Color
- Placement
- Rotation
- Flip
- Quantity

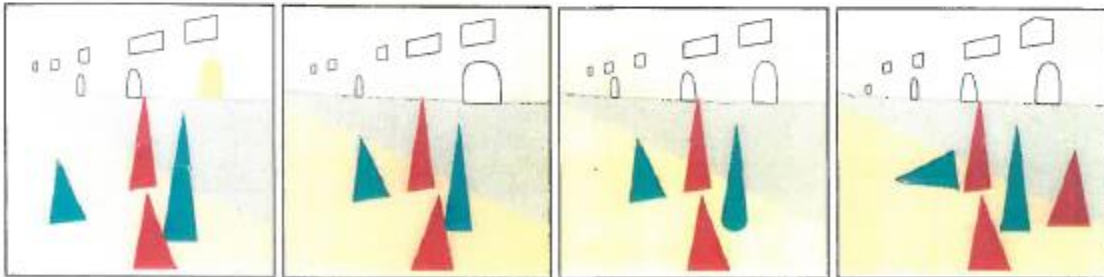

8904-001

© 2008 Donalyn Markus, Ph.D. & Associates. All rights reserved worldwide.
For permission to reprint or use these exercises, please contact: Donalyn Markus, Ph.D. & Associates, 484 Hillside Drive, Highland Park, IL 60035

Figure 7 Figure analogies with two elements.

With rule-extraction, *rule following*, and attention, I had Clark tease out similarities and differences in colored objects with respect to same/different: size, shape, color, direction. (See Figure 8).

As is often the case when there are attention difficulties, these problems were a challenge for Clark, for an interesting reason. When people have attention difficulties this sometimes shows up as an aversion to following rules, and finding fault with the rules. In Clark's case

because of his extreme natural skill in these areas he immediately understood the structure of these problems, and the solutions to them. Because he fully understood everything intellectually he didn't want to do the work of actually completing the manual writing out of the answers. I pointed out that when you can't follow rules your life becomes a chaotic challenge, and that he had enough challenges on his life already. I told him that the rules he was to practice did not include a component for his input and judgment: they were just rules. It is true that some rules should be challenged, especially by bright, creative people, but often challenging a rule wastes significantly more energy than simply following it. Clark diligently completed all these exercises, and over time we saw his attention improve with the simple step-by-step working through of these exercises in a calm, organized and methodical way.

Find the mistakes.

Using the variables checked on the right, compare the images that have been circled to the sample in the center square.

Put an X on the circled images that do not fit the required variables.

Circle any additional images that do fit the requirements.

Same:

- Size
- Shape
- Color
- Direction

Different:

- Size
- Shape
- Color
- Direction

Fill in the blanks: I am looking for images that are rotated _____ and are not _____.

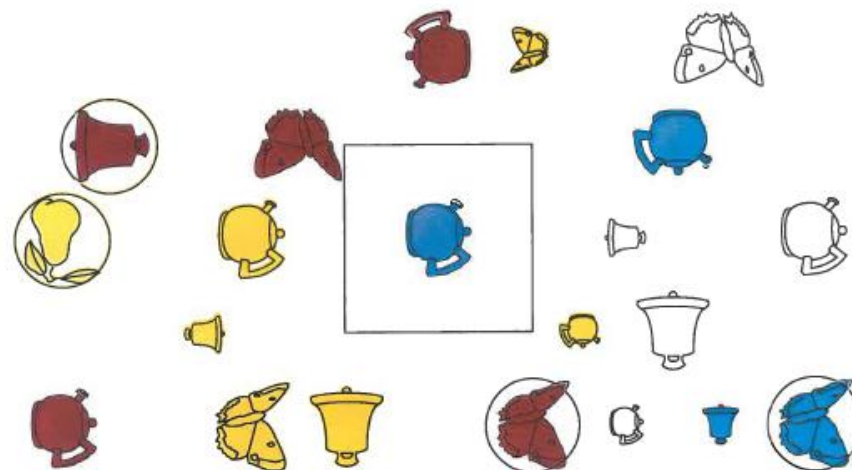

















2307o-116

Designs for Strong Minds US Pat. No. 6,755,419. All rights reserved worldwide.
© 2011 by the University of Illinois at Urbana-Champaign. All rights reserved.

Figure 8 Rule extraction, rule following, attention.

Clark had trouble with the concepts of ordinality and thus the ordering that lead to sequences. Once Clark learned to habitually identify rules and apply them, we then moved on to progressions that a required that he identify rules that dictate change and make the more complex jump from analogies to pattern detection. (See Figure 9).

Column A	Column B	Column A demonstrates a pictorial progression.
		Objective: Determine which 4 of the 8 pictures below can be used to show a similar progression in Column B. List them in sequential order in the spaces provided under Column B.
	_____	 1  2
	_____	 3  4
	_____	 5  6
	_____	 7  8
		

2203-01 progression © 2006 Donalee Markus, Ph.D. & Associates. All rights reserved worldwide. For permission to reprint or use these exercises, please contact Donalee Markus, Ph.D. & Associates, 484 Hillside Drive, Highland Park, IL 60035

Figure 9 Visual Progressions.

Clark had trouble with visually complex environments, so I had him work through path-detection puzzles where he had to create a path from one side of a six-by-six matrix puzzle to another side by matching the features of adjacent tiles. At each step he had the constraints of one correct neighboring tile, one previous tile, and two incorrect neighboring tiles.

After working with me six months, Clark was well on his way to recovery, and was transferring the conceptual re-learning from the puzzle work to real-life processes. He reported a great reduction in dispositional vigilance, and a big reduction in the inner-voice chatter that often accompanies attention difficulties. He continued for several years with therapeutic eyeglasses after my work with him was done.

My commentary: At first I struggled with even the easiest of the dots puzzles (requiring me to find simple triangles and squares), and I had to pace myself carefully so that the cognitive load of completing the homework did not interfere with my responsibilities as a father and a professor. For example, if I pushed myself too far I would get the seizures discussed earlier in the text. With practice I made steady progress in working toward more difficult puzzles. I found that as my ability to *see* the shapes rising out of the dots puzzles improved, I also began to apply the geometry of objects and relationships to my real world environment. For example, as I practiced re-learning what triangles were my ability to once again understand social situations that had three people in them (including myself as one

of them) improved. I was prompted to think that perhaps I was rebuilding the cognitively impenetrable early vision module discussed by Pylyshyn (4) and once again presenting meaningful representations to my higher-order visual-spatial interpretation systems.

By the time I was working (mostly in my head) on pages full of dots representing numerous and overlapping 3D objects, I experienced a re-awakening of my mental capacities for the kind of spatial reasoning needed for the representation of hard problems when designing computer code for artificial intelligence models.

I had a strong aversion to completing the “determine the rule” puzzles, which I easily solved (see Figure 8), and found painful to actually work through because of the visual burden requiring me to attend to small details throughout the physical writing out of the responses. At Dr. Markus’s insistence I persisted. I found that my ability to stay focused on problems, without my mind wandering, improved as I continued to work on these puzzles. The process of determining the rule, and simply following it through to completion in an orderly and somewhat pedestrian way, while attending to myriad details was unusual for me. I found that the ability to use these orderly procedures also translated into real life processes as well.

I worked very hard on all of the puzzles given to me—really pushing myself to the limit—and rarely missed a day’s practice with them over the course of six months. I completed a thousand pages of paper and pencil puzzles over the course of my treatment.

COREY FEINBERG, M.A., qEEG-T, QUANTITATIVE EEG COMPARISONS WITH AND WITHOUT THERAPEUTIC EYEGASSES

In August of 2016, as part of data-gathering for a larger project, Corey Feinberg, M.A., qEEG-T, took nineteen-channel quantitative electroencephalograph (qEEG) recordings of my brain. Out of curiosity we took measurements with my therapeutic glasses on, and the same (interleaved) measurements with them off. These were clinical recordings and not in a controlled research environment so we are constrained in assumptions we might make, but the analysis of the recordings are of some case interest, and also illustrate the types of empirical measurements and statistical analysis possible with qEEG and LORETA technology when exploring treatment for brain injury.

The qEEG recordings measured electrical activity in my brain at different wavelengths from delta waves at 1 Hz up through the gamma wave range at 30 Hz. The nineteen-channel qEEG recording allowed us to isolate the brainwave energy in different parts of my brain both at the surface level (qEEG) and in the lower brain structures (Low resolution brain electromagnetic tomography—LORETA). The measurements were made in a resting state with my eyes closed to filter out the peripheral and center visual retinal pathways, but to allow enough ambient light through to trigger the non-image-forming retinal pathways.

qEEG and LORETA analysis was performed on the data, and my electrical activity patterns were compared to a normative database grouped by age and gender. These comparisons yielded Z-scored statistical measures indicating how— and to what extent—my brain activity resembled or differed from the database norm. Figure 10 and Figure 11 illustrate these Z-scored comparisons in measures of power (amount of energy in a given frequency

band) on the surface values, and Figure 12 and Figure 13 show the LORETA (lower brain structures) comparisons. In each case the contrast is shown between the values when not wearing my therapeutic eyeglasses and when wearing my therapeutic eyeglasses.

Corey Feinberg writes:

When we took clinical measurements with Clark's glasses off, we saw clear Z-score deviations from the normative database in the high beta range. In Figure 10 the amount of red color across the posterior parietal portion of the cortical surface indicates several standard deviations from the database norm in the 22 Hz and 23 Hz high beta range. In Figure 11, the second condition, with Clark's therapeutic glasses on we see a slight increase in deviation from the normative database in the 21 Hz range, but a great reduction in abnormal activity in the 22 Hz and 23 Hz range. Deviations from the norm in other brainwave frequencies (not shown) were within normal ranges for both conditions.

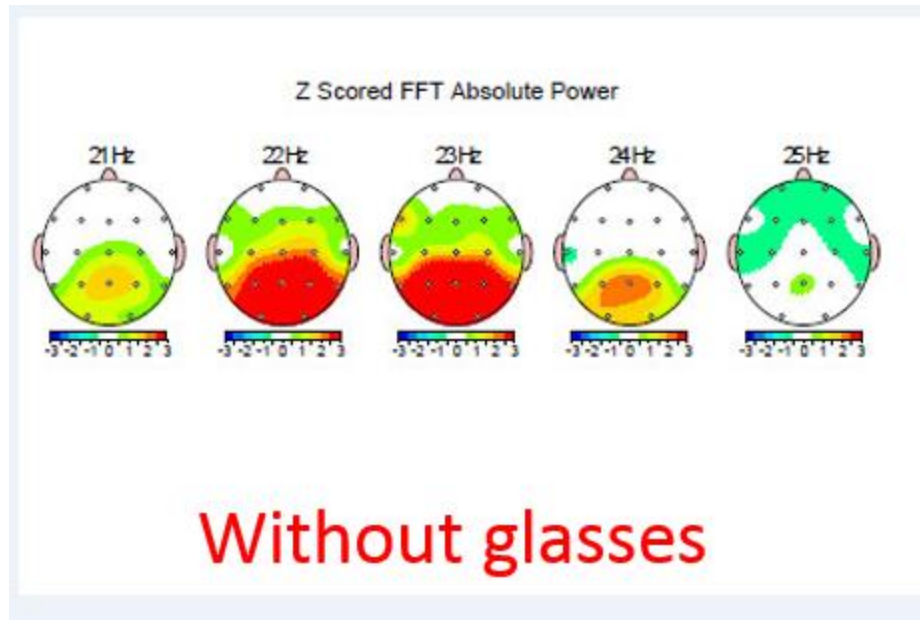

Figure 10 qEEG high beta range, condition without glasses

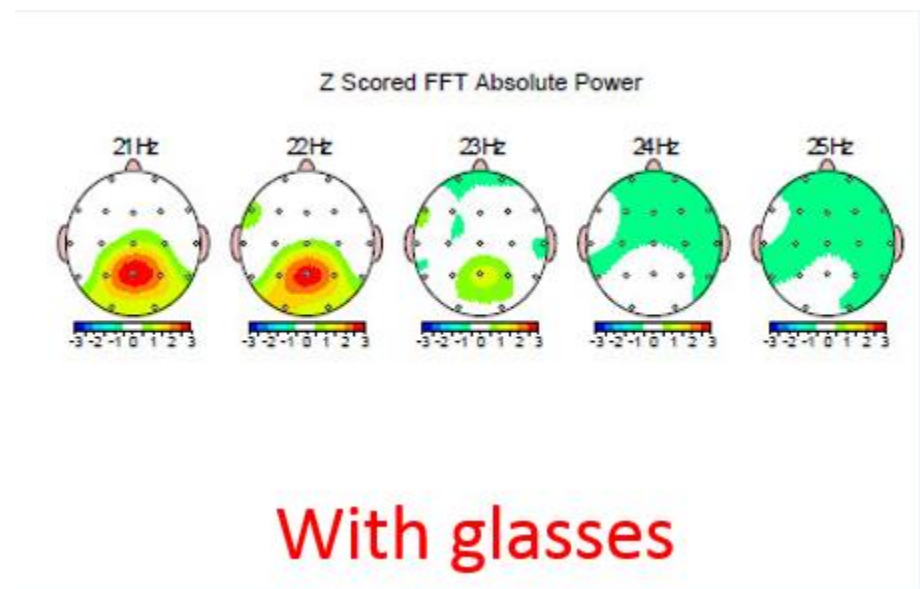

Figure 11 qEEG high beta range, condition with therapeutic glasses.

The LORETA images in Figure 12 and Figure 13 also show a significant decline in power deviations ($3.12 +SD$ down to $1.34 +SD$) indicated by the absence of red in the image representing the EEG, when the therapeutic glasses were worn. In this representation the red color completely disappeared in the second condition because the statistical deviation from the normative database became non-significant.

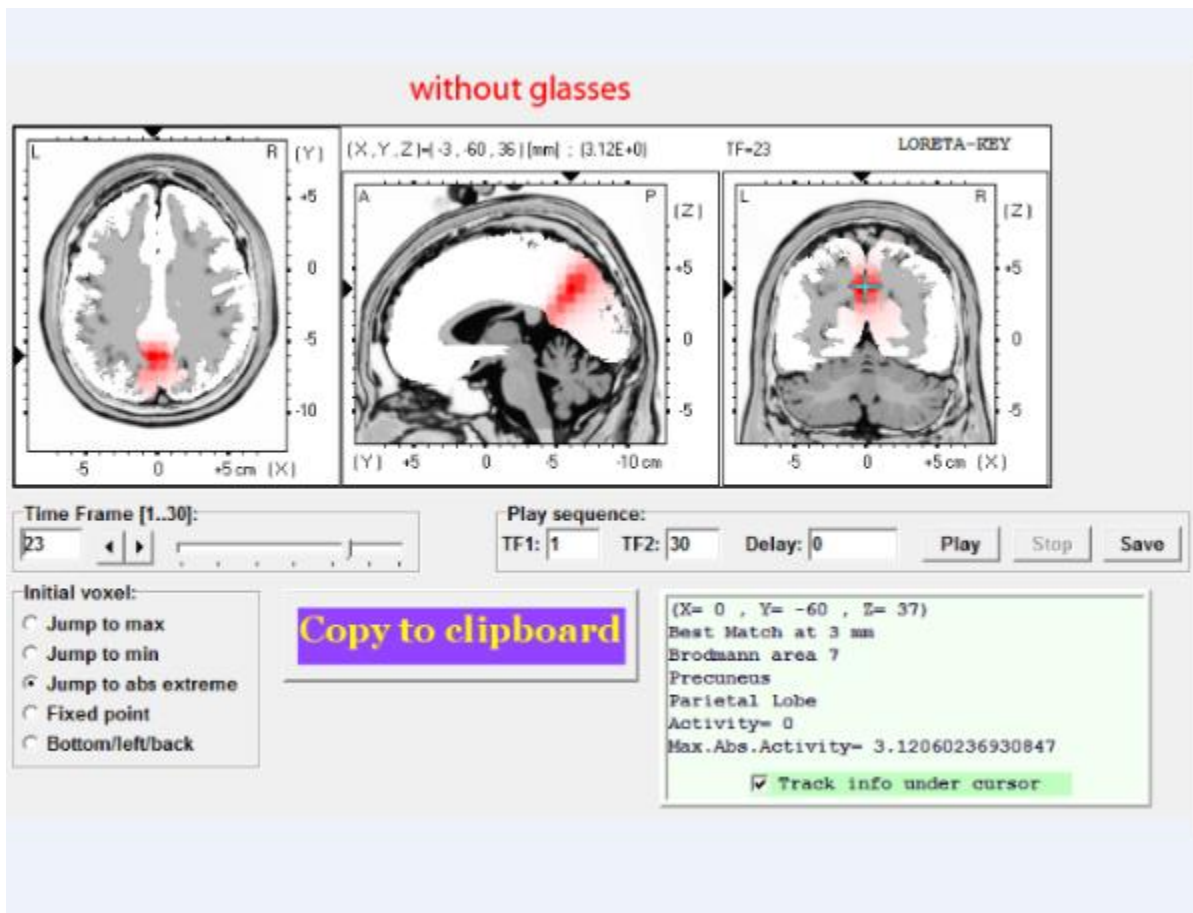

Figure 12 LORETA high beta range, condition without glasses.

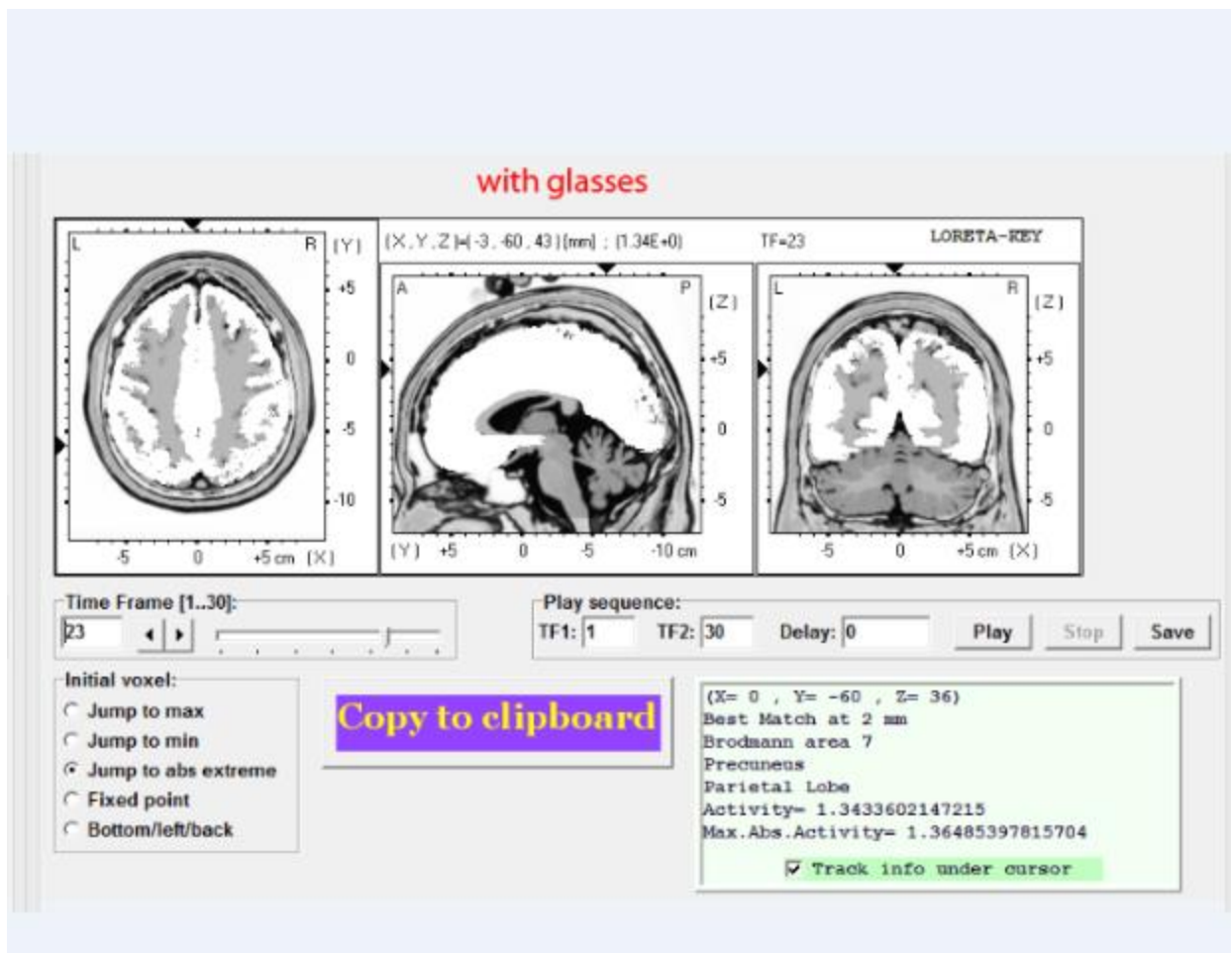

Figure 13 LORETA high beta range, condition with therapeutic glasses.

The qEEG also offers a head injury index (5) that gives a predicted probability as well as a value of severity that the characteristics of a particular EEG recording are likely the result of traumatic brain injury (TBI), using a discriminant function analysis. That is, the grouping variable predicts membership in the population category of people with prior head injuries. In the August 2016 recordings we took, with his glasses off, Clark falls clearly in the category of previously head-injured people based on this analysis, as shown in Figure 14 with a probability of 97.5%. However, interestingly the probability drops to 75% in the

qEEG data measured when he had his therapeutic glasses on, as shown in Figure 15. Additionally, the TBI severity score decreased from 3.94 down to 2.77 between the two conditions, reducing the predicted TBI severity from a moderate range into a mild range.

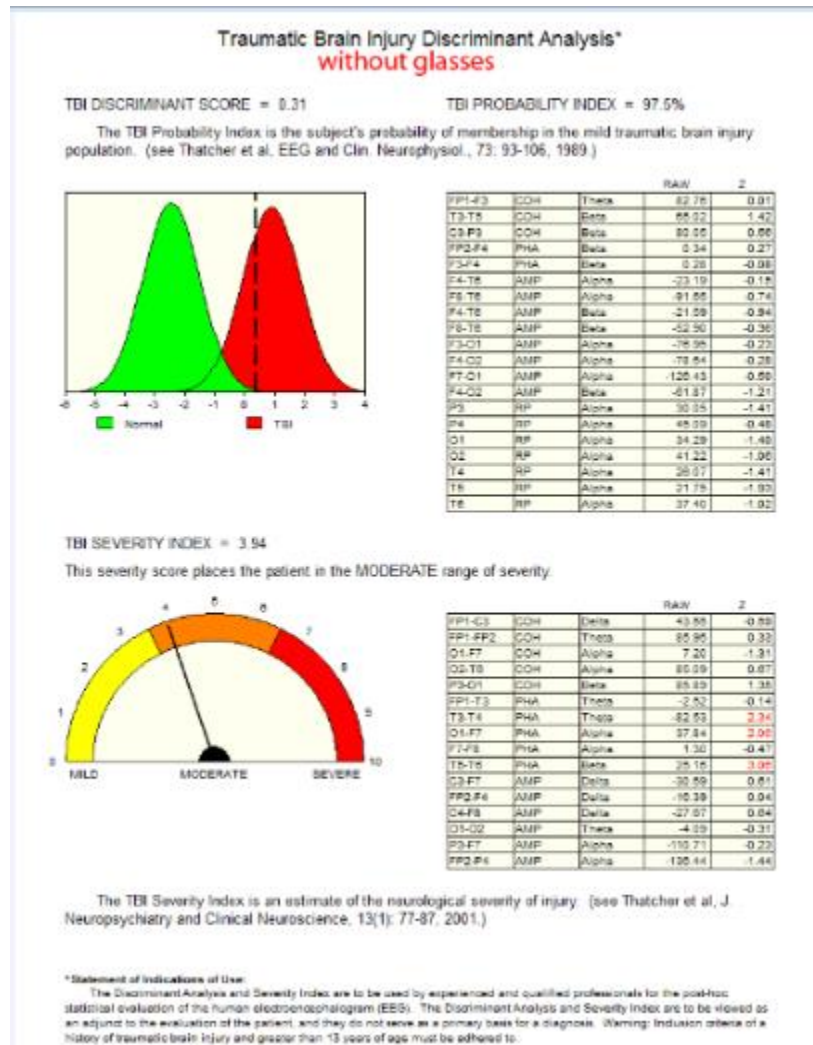

Figure 14 Brain injury index predicted probability and severity, condition without glasses.

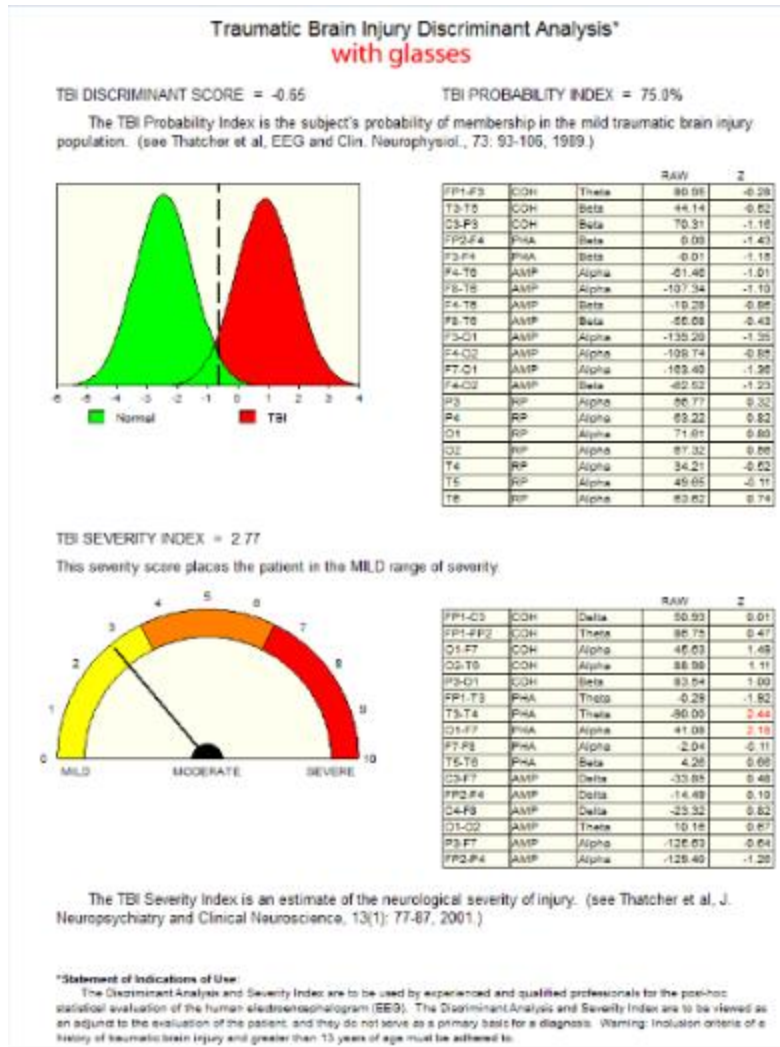

Figure 15 Brain injury index predicted probability and severity, condition with glasses.

RESULTS

The result of treatment via retinal stimulation, using neurodevelopmental optometric rehabilitation techniques and prescription eyeglasses, in concert with cognitive

restructuring with visual puzzles was that *all* of the problems with movement and cognition discussed above, and many score other difficulties not mentioned in this paper, were fully resolved. In addition some life-long dispositional attentional difficulties were also addressed. The resolution of my mTBI symptoms are considered permanent though I continue to wear my therapeutic eyeglasses. Clinical qEEG analysis suggests they are still providing a therapeutic effect.

REFERENCES

1. Elliott, C. *The Ghost In My Brain: How A Concussion Stole My Life and How The New Science Of Brain Plasticity Helped Me Get It Back*. New York: Viking Penguin, 2015.
2. Zelinsky, D. Neuro-optometric Diagnosis, Treatment and Rehabilitation Following Traumatic Brain Injuries: A Brief Overview. *Phys Med and Rehabil Clin N Am* 2007; 18 No. 1:87-107
3. Markus, D. *Designs for Strong Minds'* Cognitive Rehabilitation for Mild and Moderate Posttraumatic Head Injuries. *Phys Med and Rehabil Clin N Am* 2007; 18 No. 109-131.
4. Pylyshyn, Z. Is vision continuous with cognition? The case for cognitive impenetrability of visual perception. *Behavioral and Brain Sciences* 1999;22:341-423
5. Thatcher RW1, North DM, Curtin RT, Walker RA, Biver CJ, Gomez JF, Salazar AM. An EEG severity index of traumatic brain injury. *J Neuropsychiatry Clin Neurosci*. 2001 Winter;13(1):77-87.